



User's Guide



Shop online at

omega.com[®]

OMEGA[®]

omega.com

e-mail: info@omega.com

For latest product manuals:
omegamanual.info

ISO 9001
CERTIFIED
CORPORATE QUALITY

STAMFORD, CT

ISO 9002
CERTIFIED
CORPORATE QUALITY

MANCHESTER, UK

M-4292/1006 PCL340 Series



OMEGAnet® Online Service www.omega.com	Internet e-mail info@omega.com
---	---

Servicing North America:

USA: One Omega Drive, Box 4047
ISO 9001 Certified Stamford CT 06907-0047
Tel: (203) 359-1660 FAX: (203) 359-7700
e-mail: info@omega.com

Canada: 976 Bercar
Laval (Quebec) H7L 5A1, Canada
Tel: (514) 856-6928 FAX: (514) 856-6886
e-mail: info@omega.ca

For immediate technical or application assistance:

USA and Canada: Sales Service: 1-800-826-6342 / 1-800-TC-OMEGA®
Customer Service: 1-800-622-2378 / 1-800-622-BEST®
Engineering Service: 1-800-872-9436 / 1-800-USA-WHEN®
TELEX: 996404 EASYLINK: 62968934 CABLE: OMEGA

Mexico: En Español: (001) 203-359-7803 e-mail: espanol@omega.com
FAX: (001) 203-359-7807 info@omega.com.mx

Servicing Europe:

Benelux: Postbus 8034, 1180 LA Amstelveen, The Netherlands
Tel: +31 (0)20 3472121 FAX: +31 (0)20 6434643
Toll Free in Benelux: 0800 0993344
e-mail: sales@omegaeng.nl

Czech Republic: Frystatska 184, 733 01 Karviná, Czech Republic
Tel: +420 (0)59 6311899 FAX: +420 (0)59 6311114
Toll Free: 0800-1-66342 e-mail: info@omegashop.cz

France: 11, rue Jacques Cartier, 78280 Guyancourt, France
Tel: +33 (0)1 61 37 2900 FAX: +33 (0)1 30 57 5427
Toll Free in France: 0800 466 342
e-mail: sales@omega.fr

Germany/Austria: Daimlerstrasse 26, D-75392 Deckenpfronn, Germany
Tel: +49 (0)7056 9398-0 FAX: +49 (0)7056 9398-29
Toll Free in Germany: 0800 639 7678
e-mail: info@omega.de

United Kingdom: One Omega Drive, River Bend Technology Centre
ISO 9002 Certified Northbank, Irlam, Manchester
M44 5BD United Kingdom
Tel: +44 (0)161 777 6611 FAX: +44 (0)161 777 6622
Toll Free in United Kingdom: 0800-488-488
e-mail: sales@omega.co.uk

It is the policy of OMEGA to comply with all worldwide safety and EMC/EMI regulations that apply. OMEGA is constantly pursuing certification of its products to the European New Approach Directives. OMEGA will add the CE mark to every appropriate device upon certification.

The information contained in this document is believed to be correct, but OMEGA Engineering, Inc. accepts no liability for any errors it contains, and reserves the right to alter specifications without notice.

WARNING: These products are not designed for use in, and should not be used for, human applications.

1. Introduction	1
1.1 Contacting OMEGA	1
1.2 Standard Equipment	1
1.3 Safety Information	1
2. Calibrator Interface	4
2.1 Calibrator Display	5
2.2 Using the Backlight	9
2.3 Using the Zero Function	9
2.4 Other Menu Controlled Functions	9
3. Measuring Pressure	12
3.1 Media Compatibility	12
3.2 Measuring Pressure with External Modules	12
4. Measuring Current	13
5. Measuring Voltage	14
6. Performing a Pressure Switch Test	15
7. Calibrating Transmitters	17
7.1 Using the mA Input Function	17
7.2 Calibrating a Pressure-to-Current Transmitter	18
7.3 Percent Error Function	18
8. Factory Setups	21
9. Remote Operation	23
9.1 Remote Interface	23
9.2 Setting up the RS-232 Port for Remote Control	23
9.3 Changing Between Remote and Local Operation	24
9.4 Using Commands	24
9.5 Remote Commands and Error Codes	27
9.6 Entering Commands	29
10. Specifications	35
11. Maintenance	36
11.1 Replacing Batteries	36
11.2 Cleaning the Unit	36
11.3 Service Center Calibration or Repair	36

1. Introduction

The OMEGA PCL340 Series is designed to be a simple to use yet very versatile pressure calibrator. Its internal pressure sensor combined with inputs for mA, voltage and switch contacts allow the PCL340 Series to calibrate a variety of pressure devices. An external pressure module option allows an even wider range of pressure calibration options including absolute and differential.

1.1 Customer Service

Omega Engineering

One Omega Drive
Box 4047
Stamford, CT 06907-0047

Tel: (203) 359-1660

Fax: (203) 359-7900

www.omega.com

email: info@omega.com





1.2 Standard Equipment









Check to see if your calibrator is complete. It should include: PCL340 Series Calibrator, instruction manual, test leads, carrying case, calibration certificate with data.

1.3 Safety information

Symbols Used

The following table lists the International Electrical Symbols. Some or all of these symbols may be used on the instrument or in this manual.

Symbol	Description
	AC (Alternating Current)
	AC-DC
	Battery
	CE Complies with European Union Directives
	DC

Symbol	Description
	Double Insulated
	Electric Shock
	Fuse
	PE Ground
	Hot Surface (Burn Hazard)
	Read the User's Manual (Important Information)
	Off
	On

The following definitions apply to the terms “Warning” and “Caution”.

- “Warning” identifies conditions and actions that may pose hazards to the user.
- “Caution” identifies conditions and actions that may damage the instrument being used.

Use the calibrator only as specified in this manual, otherwise injury and damage to the calibrator may occur.

 **Warning**

To avoid possible electric shock or personal injury:

- Do not apply more than the rated voltage. See specifications for supported ranges.
- Follow all equipment safety procedures.
- Never touch the probe to a voltage source when the test leads are plugged into the current terminals.
- Do not use the calibrator if it is damaged. Before you use the calibrator, inspect the case. Look for cracks or missing plastic. Pay particular attention to the insulation surrounding the connectors.

- Select the proper function and range for your measurement.
- Make sure the battery cover is closed and latched before you operate the calibrator.
- Remove test leads from the calibrator before you open the battery door.
- Inspect the test leads for damaged insulation or exposed metal. Check test leads continuity. Replace damaged test leads before you use the calibrator.
- When using the probes, keep your fingers away from the probe contacts. Keep your fingers behind the finger guards on the probes.
- Connect the common test lead before you connect the live test lead. When you disconnect test leads, disconnect the live test lead first.
- Do not use the calibrator if it operates abnormally. Protection may be impaired. When in doubt, have the calibrator serviced.
- Do not operate the calibrator around explosive gas, vapor, or dust.
- When measuring pressure, make sure the process pressure line is shut off and depressurized before you connect it or disconnect it from the pressure module.
- Disconnect test leads before changing to another measure or source function.
- When servicing the calibrator, use only specified replacement parts.
- To avoid false readings, which could lead to possible electric shock or personal injury, replace the battery as soon as the battery indicator appears.



To avoid possible damage to calibrator or to equipment under test:

- Use the proper jacks, function, and range for your measurement or sourcing application.

2. Calibrator Interface

Figure 1 shows the location of the process measurement inputs, while table 1 describes their use.

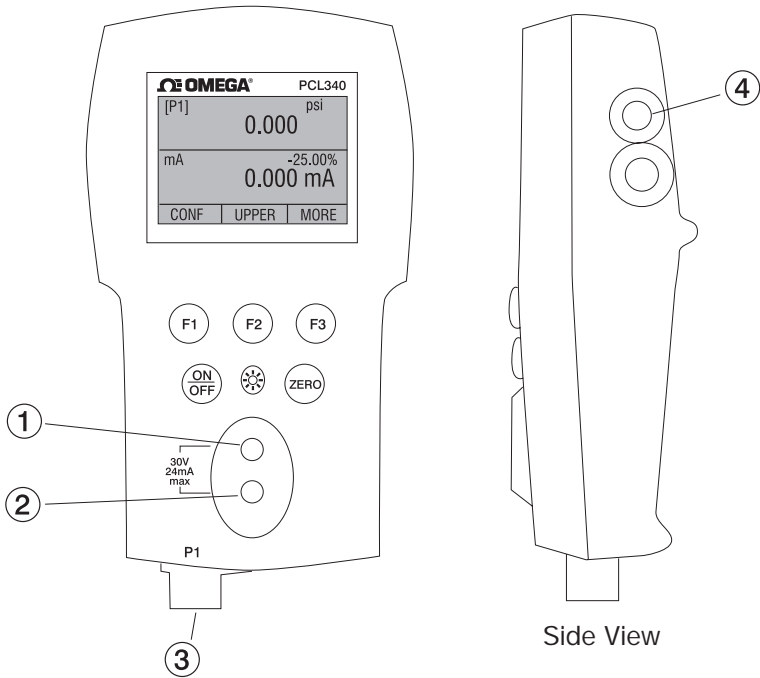

Figure 1
Process Measurement Inputs

Table 1 Process Measurement Inputs

No.	Name	Description
1, 2	Input Terminals	These terminals are used to measure current, voltage and a contact closure for switch test.
3	P1 Pressure Port	This is the connection for the internal sensor P1
4	Serial Interface	This is used to interface to optional external modules or optional serial control.

Figure 2 shows the location of the keys. Table 2 describes the function of each key.

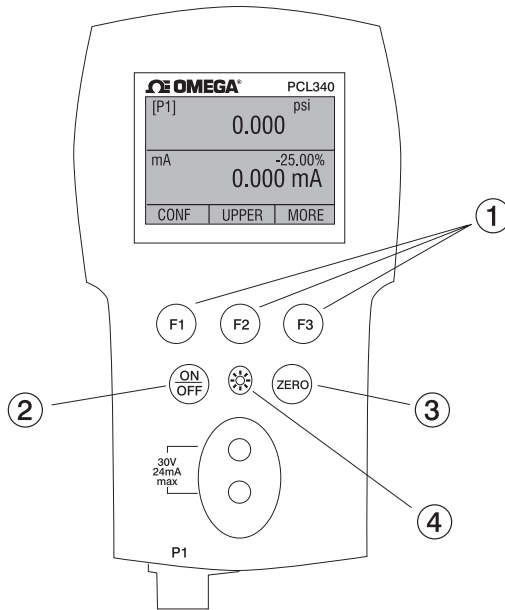

Figure 2
Keypad

Table 2 Key Functions

No.	Name	Description
1	Function Keys	These keys are used in various ways, primarily to configure the calibrator
2	ON/OFF Key	This key is used to turn the calibrator on and off
3	ZERO Key	This key is used to zero pressure measurements
4	Backlight Key	This key is used to turn the backlight on and off

2.1 Calibrator Display

The Calibrator Display consists of two regions: The menu bar (located along the bottom of the screen) is used to access a menu system. The main display (the rest) consists of up to three process measurement sub-regions. These sub-regions will henceforth be referred to as the UPPER, MIDDLE and LOWER displays. Figure 3 shows the location of the different display fields while table 3 describes them.

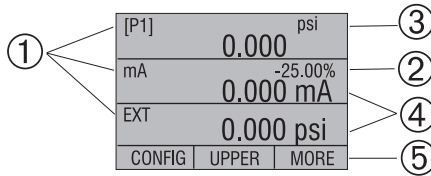

**Figure 3
Display**

Table 3 Display Functions

No.	Name	Description
1	Primary Parameters	Indicates what is being measured.
2	Span Indicator	Indicates the percent of the 4 to 20 mA span. (For mA and mA Loop functions only)
3	Pressure Units	Indicates one of 17 pressure units available for display.
4	Units	Indicates the unit of measure for the display.

2.1.1 Main Menu Functionality

There are three options on the Main Menu, CONFIG, {current display} and MORE. The Main Menu is home for the menu display.



2.1.1.1 Setting the Current Display

The current display is indicated by the center option on the Main Menu, pressing the F2 key will toggle the current display.

2.1.1.2 Setting Current Display Parameters

To set the parameters of the current display use the CONFIG option to get to the Display Configuration Menu.



Here the SELECT option will toggle through the choices for each parameter. The first parameter is MODE. Since voltage, current and switch test modes all use the same jacks, two of these functions cannot be used concurrently. The ability to select certain functions is limited based on what is already selected in another active display. The NEXT option is used to change to the second parameter. Only Pressure modes have a second parameter. Pressures can be read in 13 engineering units.

With a single display the following modes are available:

P[1] = Pressure on left side sensor.

[EXT] = Pressure with external pressure module.

P[1] ST = Switch Test with left side sensor.

[EXT] ST = Switch Test with external pressure module.

mA = Milliamps measure without loop power.

mA LOOP = Milliamps measure with loop power.

VOLTS = Voltage Measure.

The following table shows which functions are available concurrently.

An X in a column indicates that the mode in the current display will not be available for selection if the mode in that row is in use in any other active display.

Table 4 Mode Concurrency

		CURRENT DISPLAY						
OTHER DISPLAYS		P[1]	[EXT]	P[1] ST	[EXT] ST	mA	mA Loop	Volts
	P[1]							
	[EXT]							
	P[1]ST			X	X	X	X	X
	[EXT]ST			X	X	X	X	X
	mA			X	X		X	X
	mA Loop			X	X	X		X
	Volts			X	X	X	X	

2.1.1.3 Accessing Other Menus

Use the MORE option on the Main Menu to access the other menu functions.

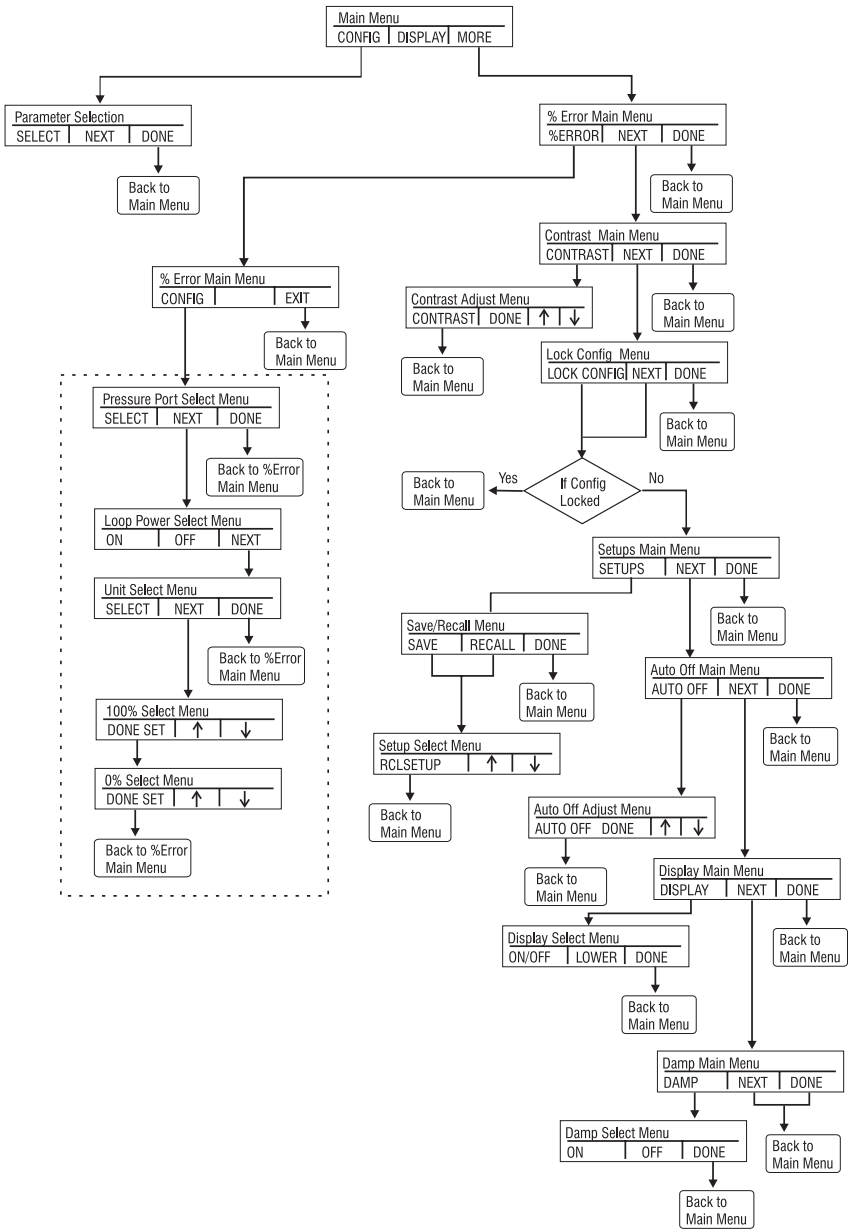

Figure 4
Menu Map

2.2 Using the Backlight

The backlight is controlled by the dedicated backlight key. It toggles on and off when the key is pressed; this is one of the few functions that cannot be controlled by the serial interface.

2.3 Using the Zero Function

When the ZERO_KEY is pressed, the calibrator will zero the current display if a pressure mode is selected, and the pressure is within the zero limit.

2.3.1 Internal Sensor and Pressure Module (non-absolute)

When a sensor or module is selected on the current display and the ZERO_KEY is pressed the calibrator subtracts the current reading from the output.

2.3.2 Absolute Pressure Module

When an absolute pressure module is selected on the current display and the ZERO_KEY is pressed the calibrator prompts the user to enter the barometric reference pressure. This is done using the arrow keys (F2 and F3 Keys).

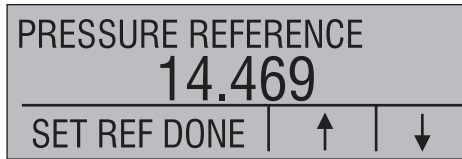

2.4 Other Menu Controlled Functions

There are eight 'sub-main' menus that can be accessed through the MORE option of the Main Menu. A 'sub-main' menu contains three options. The first option is unique to the function. The second and third options of a 'sub-main' menu are always the same. The NEXT option leads to the next 'sub-main' menu and the DONE option returns home. For the last 'sub-main' menu the NEXT option wraps around to home. See Figure 4 for a detailed mapping of the menu structure.

A note on naming convention:

If a 'sub-main' menu has subordinate menus, it will henceforth be referred to as {function} Main Menu. E.g. the display contrast sub-main menu will be called the Contrast Main Menu. If not it will be called the {function} menu.

2.4.1 Setting the Contrast

From the Contrast Main Menu choose the CONTRAST option to access the Contrast Adjustment Menu.



Use the arrow keys to adjust the display contrast to the desired level and then use the CONTRAST DONE option to return home.



2.4.2 Locking and Unlocking Configurations

Use the LOCK CFG or UNLOCK CFG option of the Configuration Lock Menu to lock or unlock the display configuration.



When the LOCK CFG option is chosen the menu display returns home and the CONFIG option on the Main Menu indicates that it is locked. Also all menus are locked out with the exception of the Contrast Adjustment menus and the Configuration Lock Menu. When the UNLOCK CFG option is chosen the configuration is unlocked and the menu display continues to the next sub-main menu.

2.4.3 Saving and Recalling Setups

The calibrator will automatically save the current set-up for recall at power-up. Additionally 5 set-ups can be accessed through the SETUPS menu. Select the SETUPS option from the Setups Main Menu.



Choose SAVE to save a set-up , RECALL to recall the set-up, or DONE to do nothing and return home.



If SAVE or RECALL is selected use the arrow keys to select the set-up location. Then use the save option to store the current set-up into the selected location or the recall option to recall the set-up stored in the selected location. The display menu will automatically go home.



2.4.4 Setting AutoShut-off Parameters

The calibrator can be set to automatically shut-off after a selected number of minutes; this function can also be disabled. To set the auto shut off parameters select the AUTO OFF option on the Auto Shut Off Main Menu.



Use the arrow keys to select the number of minutes before the calibrator turns off or disable auto shut-off by scrolling all the way down.

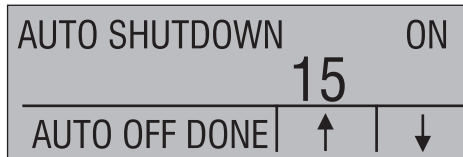

Use the AUTO OFF DONE option to set the parameters and return home. The auto shut off time is reset whenever a key is pressed.

2.4.5 Activating and Deactivating a Display

Use the DISPLAY option on the Display Selection Main Menu to access the Display Activation Menu.



The {function} option can be used to select which display to act upon. The ON/OFF option turns the selected display on or off. The selected display and current on/off state are displayed in the lower display.



Use the DONE option to save the changes and return home. When a display is deactivated its configuration is retained. When the display is activated its configuration is checked against the

configurations of the other currently active displays, if the configurations are in conflict the recalled display's configuration is modified to avoid the conflict. If all three displays are deactivated the LOWER display will come on automatically

3. Measuring Pressure

To measure pressure, connect the calibrator using an appropriate fitting. Choose a pressure setting for the display being used. The calibrator is equipped with one internal sensor and many optional external Pressure Modules are available. Be sure to choose the sensor based on working pressures and accuracy.

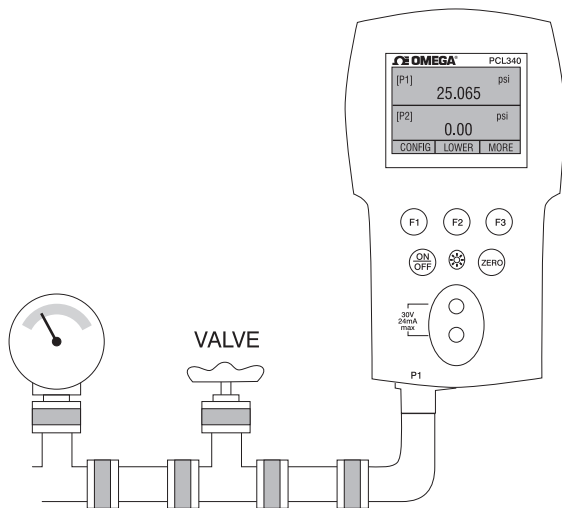

Figure 5

Use the (ZERO) key to zero the pressure sensor when vented to atmospheric pressure.

Important NOTE: To ensure accuracy of the calibrator it is critical to zero the calibrator before a device is calibrated.

3.1 Media Compatibility

The calibrator utilizes a media isolated sensor to prevent sensor contamination. Whenever possible clean, dry air is the media of choice. If that is not always possible, make sure that the media is compatible with Nickel Plated Brass, Silicon, RTV, glass, and ceramic materials.

3.2 Measuring Pressure with External Modules

The calibrator provides a digital interface to External Pressure Modules. These modules are available in various ranges and types

including gauge, vacuum, differential and absolute. The modules work seamlessly with the calibrator. Simply plug them into the interface and select [EXT] (external sensor). Since the interface between the calibrator and the module is digital all the accuracy and display resolution is derived from the module.

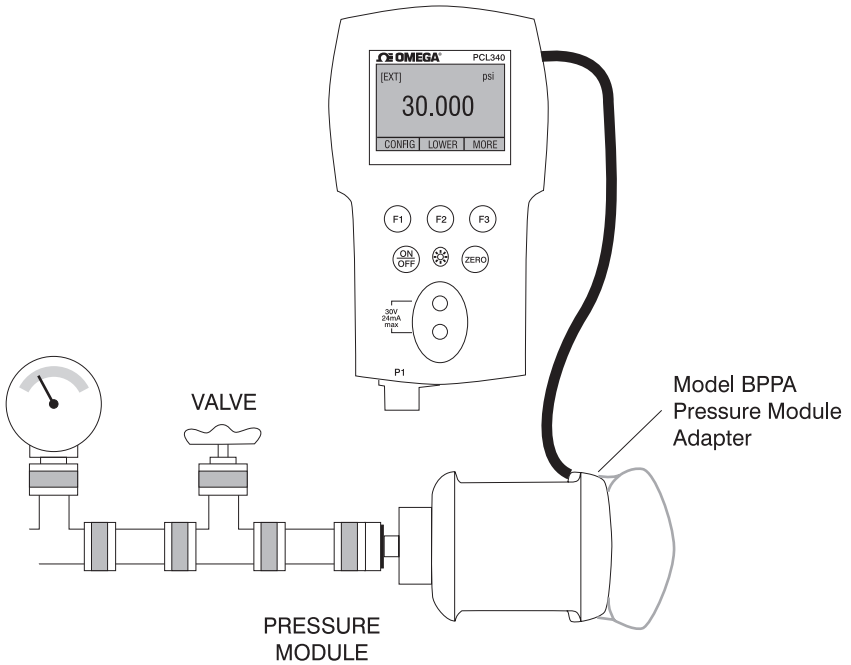

Figure 6

4. Measuring Current

To measure current use the input terminals in the front of the calibrator. Select the mA function on one of the displays. Current is measured in mA and percentage of range. The range on the calibrator is set to 0% at 4 mA and 100% at 20 mA.

For example:

If the current measured is displayed as 75% then the mA value is 16 mA.

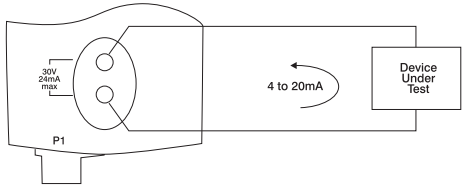
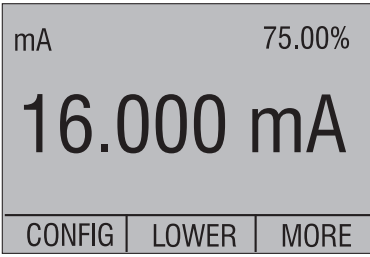

Figure 7

5. Measuring Voltage

To measure voltage use the input terminals in the front of the calibrator. Select the Volts function on one of the displays. The calibrator can measure up to 30V.

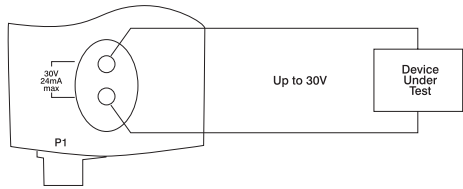
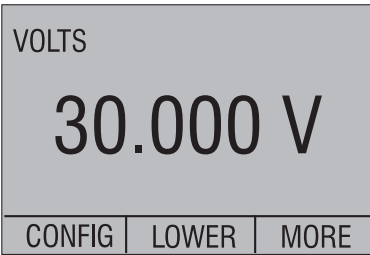

Figure 8

6. Performing a Pressure Switch Test

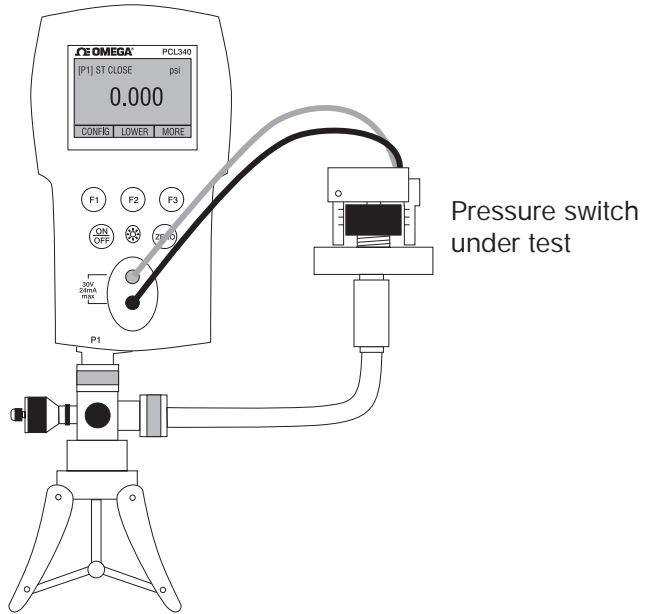

Figure 10

To perform a switch test, follow these steps:

1. Change the setup to Setup 4 (default switch test).

Setup 4: The upper display is set to [P1] ST, all other displays are off.

Important NOTE: The pressure Switch Test can be performed with the following functions [P1] ST, or EXT ST.

2. Connect the calibrator to the switch using the pressure switch terminals. The polarity of the terminals does not matter. Then connect the pump to the calibrator and the pressure switch.
3. Make sure the vent on the pump is open. Zero the calibrator if necessary. Close the vent after zeroing the calibrator.
4. The top of the display will read "CLOSE".

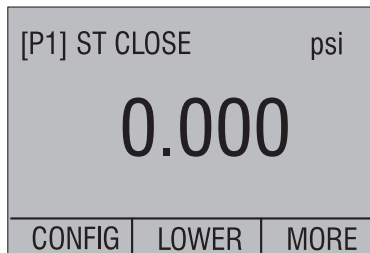

5. Apply pressure with the pump slowly until the switch opens.

Important NOTE: In the switch test mode the display update rate is increased to help capture changing pressure inputs. Even with this enhanced sample rate pressurizing the device under test should be done slowly to ensure accurate readings.

6. Once the switch is open, "OPEN" will be displayed, bleed the pump slowly until the pressure switch closes.

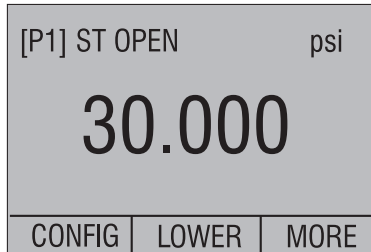

7. At the top of the display it will now read, "SW OPENED AT" and give you the pressure that the switch opened at.

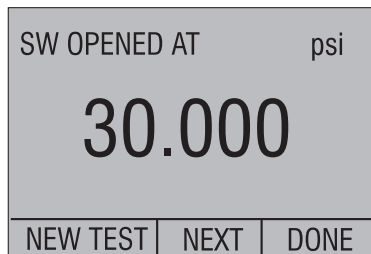

8. Press the "NEXT" option to view when the switch closed, and the dead band.

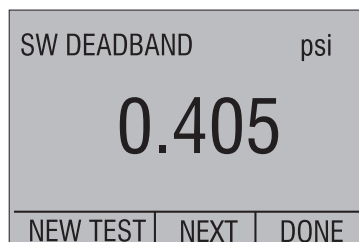
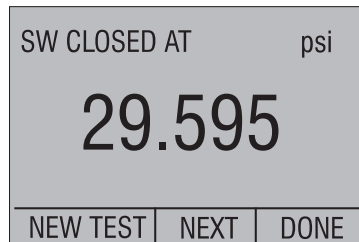

9. Press the "NEW TEST" option to clear the data and perform another test.
10. Press the "DONE" option to end the test and return to the standard pressure setting.

Example:

[P1] ST will return to [P1].

Important NOTE: The previous example uses a normally closed switch. The basic procedure is still the same for a normally open switch, the display will just read "OPEN" instead of "CLOSE".

7. Calibrating Transmitters

7.1 Using the mA Input Function

The mA input function allows the user to read back the 4-20 mA output from the device being calibrated. This can be done in one of two ways.

- 1) Passively - Where the device under test directly generates 4-20 mA and can be read by the calibrator.
- 2) Actively – Where the calibrator supplies 24 VDC loop power to the device under test to power the device while reading the resulting 4-20 mA signal.

[P1]	psi
30.000	
mA	100.00%
20.000 mA	
CONFIG	LOWER MORE

[P1]	psi
30.000	
mA LOOP	100.00%
20.000 mA	
CONFIG	LOWER MORE

7.2 Calibrating a Pressure-to-Current Transmitter

To calibrate a pressure-to-current transmitter (P/I), perform the following steps:

1. Connect the calibrator and the pump to the transmitter.
2. Apply pressure with the pump.
3. Measure the current output of the transmitter.
4. Ensure the reading is correct. If not, adjust the transmitter as necessary.

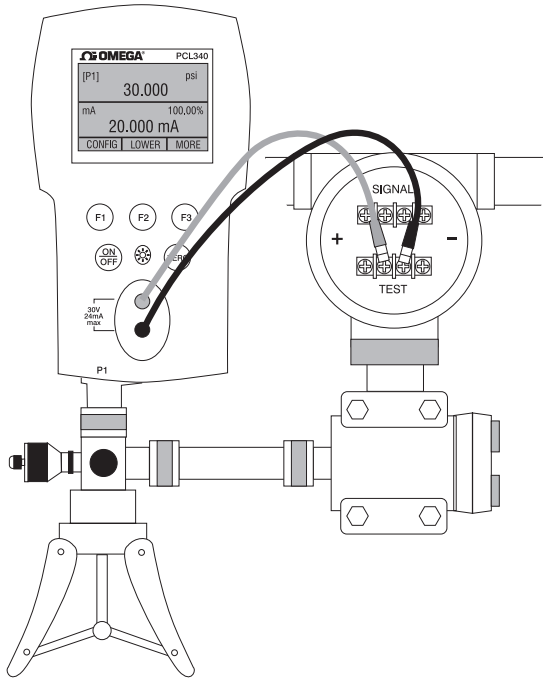

Figure 11.

7.3 Percent Error Function

The calibrator features a unique function which can calculate pressure vs. milliamp error as a percentage of the 4 to 20 mA loop span. The percent error mode uses all 3 screens and has a unique menu structure. It simultaneously displays pressure, mA and percent error.

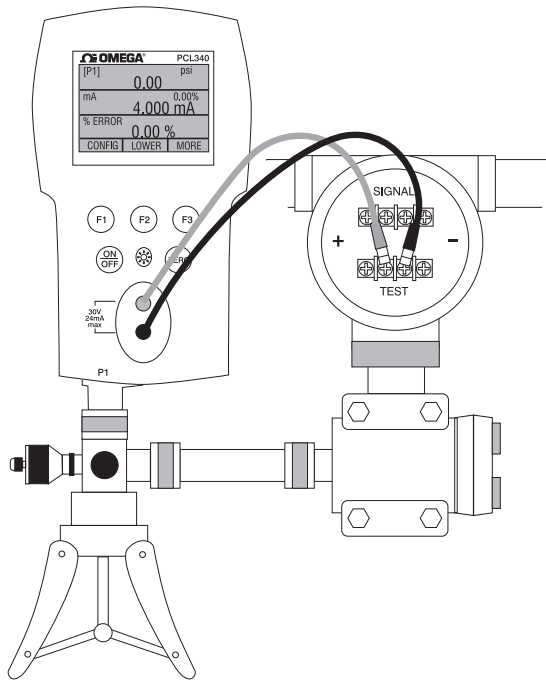

Figure 12.

Example:

Suppose a pressure transmitter under test is 30 psi (2 Bar) Full Scale and outputs a corresponding 4 to 20 mA signal. The user can program in a 0 to 30 psi pressure span into the calibrator and the calibrator will calculate and display the deviation or % Error from the expected 4 to 20 mA output. This eliminates the need for manual calculations and also helps if it becomes difficult to set an exact pressure with an external pump.

To use the %ERROR function proceed as follows:

1. With the calibrator turned on and operating press the F3 key to activate the MORE menu option. Now press the F1 key to activate the %ERROR option.
2. Press the F1 key to select the CONFIG option.
3. The first option is setting the Port, use the select option to scroll through the port choices, when finished select the NEXT option.

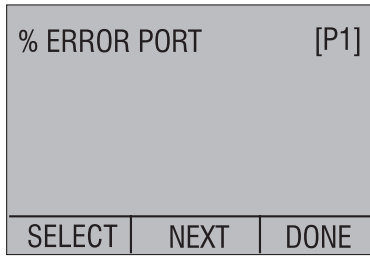

4. LOOP POWER can be toggled on/off, select NEXT when done.

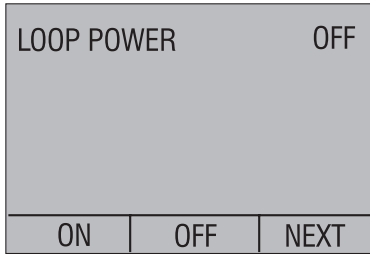

5. Use SELECT to toggle through the UNIT options, and select NEXT to move on.

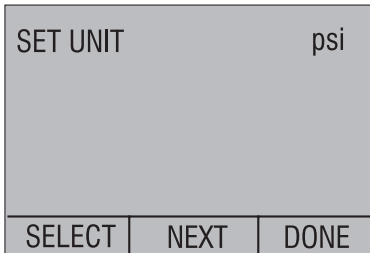

6. Use the ↑ and ↓ arrows to set the 100% point of the desired pressure range, select DONE SET when finished.

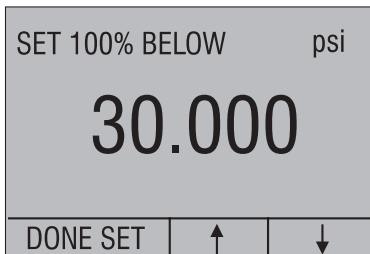

7. Again, use the arrows to set 0% point and select DONE SET when finished and the %ERROR mode will be ready to use.

SET 100% BELOW		psi
0.000		
DONE SET	↑	↓

Note: The 0% and 100% point will be saved in non-volatile memory until they are changed again by the user for the internal sensors, and external pressure modules. When using an external module the 0% and 100% are set to low and full scale of the module until the user changes it, or if it was previously saved.

8. Factory Setups

The Calibrator is loaded with five factory setups. These setups are shown below.

[P1]	psi	
30.000		
mA	100.00%	
20.000 mA		
CONFIG	UPPER	MORE

Setup 1: The upper display is set to [P1] mode and the middle is set to mA, lower is off.

EXT	psi	
0.000		
mA	100.00%	
20.000		
CONFIG	LOWER	MORE

Setup 2: The upper display is set to [EXT] mode and the middle is set to mA, lower is off.

[P1]	psi	
0.000		
VOLTS	V	
0.000		
CONFIG	LOWER	MORE

Setup 3: The upper display is set to [P1] mode and the middle is set to [VOLTS] mode, lower is off.

[P1]	psi	
0.000		
[EXT]	psi	
0.000		
CONFIG	LOWER	MORE

Setup 4: The upper display is set to [P1], the lower display is set to [EXT].

[P1]	psi	
0.000		
mA Loop	100.00%	
20.000		
CONFIG	LOWER	MORE

Setup 5: The upper display is set to [P1], and the lower display is set to mA Loop.

9. Remote Operation

9.1 Remote Interface

The calibrator can be remotely controlled using a PC terminal, or by a computer program running the calibrator in an automated system. It uses an RS-232 serial port connection for remote operation.

NOTE: To use the remote control option a custom RS-232 cable must be purchased from OMEGA (LEM232). To contact OMEGA refer to Section 1.1 of this manual. With this connection the user can write programs on a PC, with Windows languages like Visual Basic to operate the calibrator, or use a Windows terminal, such as Hyper Terminal, to enter single commands. Typical RS-232 remote configurations are shown in Figure 13.

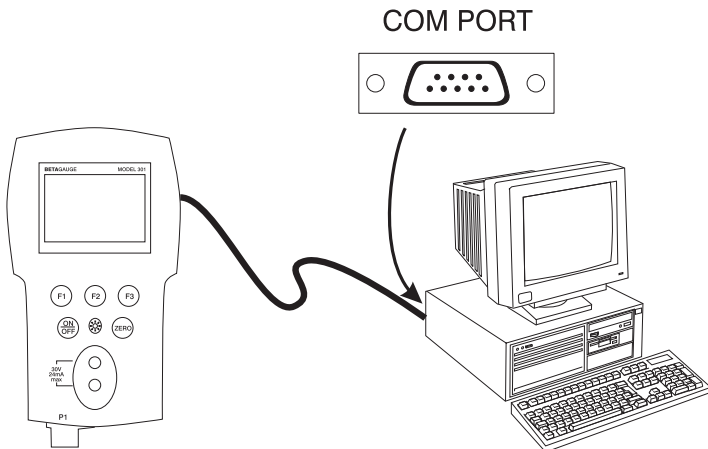

Figure 13. Calibrator-to-Computer Connection

9.2 Setting up the RS-232 Port for Remote Control

Note: The RS-232 connection cable should not exceed 15m unless the load capacitance measured at connection points is less than 2500pF.

Serial parameter values:

9600 baud

8 data bits

1 stop bit

no parity

Xon/Xoff

EOL (End of Line) character or CR (Carriage Return) or both

To set up remote operation of the calibrator on the Windows Hyper Terminal, connected to a COM port on the PC as in Figure 23, use the following procedure:

1. Start Hyper Terminal (located in Accessories/Communications of the Windows Start menu)
2. Select New Connection.
3. For Name enter PCL340. Select the serial port that the calibrator is connected to.
4. Enter the above information for port settings.
5. Select ASCII setup from File/Properties/Settings and mark these choices:
 - Echo typed characters locally
 - Wrap lines that exceed terminal width
6. Select Ok
7. To see if the port works enter *IDN?. This command will return information on the calibrator.

9.3 Changing Between Remote and Local Operation

There are three modes of operation of the calibrator, Local, Remote, and Remote with Lockout. Local mode is the default mode.

Commands may be entered using the keypad on the calibrator or using a computer. In Remote mode the keypad is disabled, and commands may only be entered using a computer, but choosing [GO TO LOCAL] from the menu on the calibrator display will restore keypad operation. In Remote with Lockout, the keypad can not be used at all. To switch modes proceed as follows:

1. To enable Remote mode, type in the serial command REMOTE at the computer terminal.
2. To enable Remote with Lockout, type in "REMOTE LOCKOUT" in either order.
3. To switch back to local operation enter LOCAL at the terminal. This command also turns off LOCKOUT if it was on. For more information on commands refer to the Remote Commands section.

9.4 Using Commands

9.4.1 Command types

Refer to the Section 10.5 on Remote Commands for all available commands.

The calibrator may be controlled using commands and queries. All commands may be entered using upper or lower case. The commands are divided into the following categories:

Calibrator Commands

Only the calibrator uses these commands. For example

VAL?

asks for the values displayed on the calibrator display.

Common Commands

Standard commands used by most devices. These commands always begin with an "*" . For example

*IDN?

tells the calibrator to return its identification.

Query Commands

Commands that ask for information, they always end with a "?". For example:

FUNC?

Returns the current modes of the calibrator displays.

Compound Commands

Commands that contain more than one command on one line. For example;

PRES_UNIT LOWER, PSI, PRES_UNIT?

Sets the pressure units to PSI and queries it to verify. It will return:

PSI, PSI, PSI

9.4.2 Character Processing

The data entered into the calibrator is processed as follows:

- ASCII characters are discarded if their decimal equivalent is less than 32 (space), except 10 (LF) and 13 (CR):
- Data is taken as 7-bit ASCII
- The most significant data bit is ignored.
- Upper or lower case is acceptable.

9.4.3 Response Data Types

The data returned by the calibrator can be divided into four types:

Integer

For most computers and controllers they are decimal numbers ranging from -32768 to 32768. For example:

FAULT? could return 110

Refer to the Error Codes table (Table 8) for more information on error codes.

Floating

Floating numbers have up to 15 significant figures and exponents. For example:

ZERO_MEAS returns 1.210000E-2, PSI

Character Response Data (CRD)

Data returned as keywords. For example:

PRES_UNIT? returns PSI, NONE, NONE

Indefinite ASCII (IAD)

Any ASCII characters followed by a terminator. For example:

*IDN? returns BETA, 301, 250, 1.00

9.4.4 Calibrator Status

Error Queue

If an error occurs due to invalid input or buffer overflow, its error code is sent to the error queue. The error code can be read from the queue with the command FAULT?. The error queue holds 15 error codes. When it is empty, FAULT? returns 0. The error queue is cleared when power is reset or when the clear command *CLS is entered.

Input Buffer

Calibrator stores all received data in the input buffer. The buffer holds 250 characters. The characters are processed on a first in, first out basis.

9.5 Remote Commands and Error Codes

The following tables list all commands, and their descriptions, that are accepted by the calibrator.

Table 5: Common Commands

Command	Description
*CLS	(Clear status.) Clears the error queue.
*IDN?	Identification query. Returns the manufacturer, model number, and firmware revision level of the Calibrator.
*RST	Resets the calibrator to the power up state.

Table 6: Calibrator Commands

Command	Description
DAMP	Turns Damp on or off.
DAMP?	Returns if DAMP is on/off
DISPLAY	Turns on/off the displays specified in the command
DISPLAY?	Returns which displays are on/off
FAULT?	Returns the most recent error code
ERROR_LOOP	Turns loop power on or off in percent error mode
ERROR_LOOP?	Returns the current state of loop power in error mode
ERROR_MODE	Turns percent error mode on or off
ERROR_MODE?	Returns whether percent error mode is on or off
ERROR_PORT	Set the pressure port for percent error mode
ERROR_PORT?	Returns the pressure port for percent error mode
FUNC	Sets the display mode as specified in the command
FUNC?	Returns the current mode of the upper, middle, and lower display
HI_ERR	Sets the 100% of span limit for percent error mode
HI_ERR?	Returns the 100% of span limit for percent error mode
LOCAL	Returns user to manual operation of the calibrator
LOCKOUT	Locks out the keypad of the calibrator in remote operation
LO_ERR	Sets the 0% of span limit for percent error mode
LO_ERR?	Returns the 0% of span limit for percent error mode
PRES_UNIT	Set the pressure unit for the indicated display
PRES_UNIT?	Returns the pressure from the indicated display
REMOTE	Puts the calibrator in remote mode

ST_START	Starts a switch test
ST_OPEN?	Returns pressure value at which the switch opened
ST_CLOSE?	Returns pressure value at which the switch closed
ST_DEAD?	Returns pressure value of the deadband of the switch
VAL?	Returns the measured values
ZERO_MEAS	Zeros the pressure module
ZERO_MEAS?	Returns the zero offset of the pressure module

Table 7: Parameter units

Units	Meaning
MA	milliamps of current
V	Voltage in volts
PSI	Pressure in pounds per square-inch
INH2O4C	Pressure in inches of water at 4°C
INH2O20C	Pressure in inches of water at 20°C
CMH2O4C	Pressure in centimeters of water at 4°C
CMH2O20C	Pressure in centimeters of water at 20°C
BAR	Pressure in bars
MBAR	Pressure in millibars
KPAL	Pressure in kiloPascals
INHG	Pressure in inches of mercury at 0°C
MMHG	Pressure in millimeters of mercury at 0°C
KG/CM2	Pressure in kilograms per square-centimeter
ON	Turn something on
OFF	Turn something off
UPPER	Upper Display
MIDDLE	Middle Display
LOWER	Lower Display
DCI	Current measure function
DCI_LOOP	Current measure function with loop power
DCV	Voltage measure function
P1	Port P1 pressure measure function
P1_ST	Switch Test with port P1 pressure measure function

Table 8: Error Codes

Error Number	Error Description
100	A non-numeric entry was received where it should be a numeric entry
101	Too many digits entered
102	Invalid units or parameter value received
103	Entry is above the upper limit of the allowable range
104	Entry is below the lower limit of the allowable range
105	A required command parameter was missing
106	An invalid command parameter was received
107	Pressure not selected
108	Invalid sensor type
109	Pressure module not connected
110	An unknown command was received
111	Bad Parameter received
112	The serial input buffer overflowed
113	Too many entries in the command line
114	The serial output buffer overflowed

9.6 Entering Commands

Commands for the calibrator may be entered in upper or lower case. There is at least one space required between the command and parameter, all other spaces are optional. Almost all commands for the calibrator are sequential; any overlapped commands will be indicated as such. This section will briefly explain each of the commands and describe their general use, which will include any parameters that may be entered with the command as well as what the output of the command is.

9.6.1 Common Commands

***CLS**

Clears the error queue. Also terminates all pending operations. When writing programs, use before each procedure to avoid buffer overflow.

***IDN?**

Returns the manufacturer, model number, and firmware revision of the Calibrator. For example:

*IDN? will return BETA, 301, 0, 1.00

9.6.2 Calibrator Commands

DAMP

Turns the dampening function on or off.

For example:

If you send DAMP ON this will turn the dampening function on.

DAMP?

Returns the current state of the dampening function.

For example:

If you send DAMP? It will return ON if the dampening function is on.

DISPLAY

Turns the indicated display on or off.

For example:

If you send DISPLAY LOWER, ON this will turn the lower display on.

DISPLAY?

Returns the current state of the each of the displays.

For example:

If you send DISPLAY? It will return ON, ON, ON if the all the displays are on.

FAULT?

Returns the error code number of an error that has occurred.

The command may be entered when the previous command did not do what it was meant to do.

For example, if a value for current output is entered that is bigger than the supported range (0-24mA) FAULT? Would return:

103 which is the code number for an entry over range.

Refer to the Error Codes table for more information on error code numbers.

ERROR_LOOP

Turns loop power on or off in percent error mode.

For example:

To set loop power on send ERROR_LOOP ON.

ERROR_LOOP?

Returns the current state of loop power in percent error mode.

For example:

If you send ERROR_LOOP? It will return ON if loop power is on in error mode.

ERROR_MODE

Turns percent error mode on and off.

For example:

To turn on percent error mode send ERROR_MODE ON.

ERROR_MODE?

Returns the current state of percent error mode.

For example:

If you send ERROR_MODE? It will return ON if the calibrator is in percent error mode.

ERROR_PORT

Sets the pressure port for percent error.

For example:

To set the pressure port for percent error to [P1] send ERROR_PORT P1.

ERROR_PORT?

Returns the current pressure port for percent error mode.

For example:

If you send ERROR_PORT?, it will return P1 if the pressure port in percent error is [P1].

FUNC

Sets the display indicated in argument one to the function indicated in argument 2.

For example:

To set the lower display to P1 Pressure mode send FUNC LOWER,P1.

FUNC?

Returns the current mode of all displays. For example if the calibrator is set to [P1] ST on the upper display, [P1] on the middle, and the lower display is off, FUNC? Would return:

ST_P1,P1,NONE

HI_ERR

Sets the 100% point for the percent error mode calculation in the current engineering units.

For example:

To set the 100% point to 100 psi send HI_ERR 100.

HI_ERR?

Returns the 100% point for the percent error mode calculation.

For example:

If the 100% point is set to 100 psi, HI_ERR? would return 1.000000E+02, PSI .

LOCAL

Restores the calibrator to local operation if it was in remote mode. Also clears LOCKOUT if the calibrator was in lockout mode.

LOCKOUT

Sending this command sets the lockout state, when the unit is in REMOTE or goes to remote it prohibits use of the keypad completely. The lockout state can only be cleared by sending the LOCAL command.

LO_ERR

Sets the 0% point for the percent error mode calculation in the current engineering units.

For example:

To set the 0% point to 20 psi send LO_ERR 20.

LO_ERR?

Returns the 0% point for the percent error mode calculation.

For example:

If the 0% point is set to 20 psi, LO_ERR? would return 2.000000E+01, PSI .

PRES_UNIT

Used to set the pressure unit for the indicated display

For example:

To set the pressure unit to psi on the lower display send PRES_UNIT LOWER, PSI.

PRES_UNIT?

Returns the pressure unit used when measuring pressure for each of the 3 displays.

REMOTE

Puts the calibrator in remote mode. From the remote mode the user can still use the keypad to get back to local unless the command LOCKOUT was entered before REMOTE. Then the keypad is totally locked out, and the user has to send the LOCAL command to get back to local operation.

ST_START

Starts a switch test.

ST_CLOSE?

Returns the pressure that the switch closed at in the current pressure units.

ST_OPEN?

Returns the pressure that the switch opened at in the current pressure units.

ST_DEAD?

Returns deadband of the switch in the current pressure units.

VAL?

Returns the value of any measurement taking place on the upper and lower display. For example, if the upper display is measuring 5mA, and the lower display is measuring 10V, then VAL? will return:

5.000000E-03, A, 1.000000E+01, V

ZERO_MEAS

Zeroes the attached pressure module. Enter the zeroing value in PSI after the command when zeroing an absolute pressure module.

ZERO_MEAS?

Returns the zero offset or the reference value for absolute pressure modules.

10. Specifications (18 °C to 28 °C unless otherwise noted.)

General

Instrument Setup Recall	5; last used on power-up
Environmental Operating Temperature Storage Temperature	-10 °C to +50 °C -20 °C to +60 °C
Power Requirements Battery Battery Life	6.0 VDC Four (4) standard AA cells > 25 hours, typical usage
Physical Dimensions Weight	8.3" H x 3.9" W x 1.8" D (21.082 x 9.906 x 4.572 cm) 1 lb. 4 oz. (0.567 kg)
Connectors/Ports	Pressure - one, 1/8" NPT (2 ports on differential models) BetaPort-P pressure module
Included Accessories	Soft case, batteries, manual, NIST-traceable certificate, and test leads

Ranges

Available Pressure 1 psi, 5 psi, 30, psi, 100 psi, 300 psi	
mA	0 to 24.000 mA
Volts	0 to 30.000 VDC
Engineering Units	psi, bar, mbar, kPa, kgcm ² , cmH ₂ O@4°C, cmH ₂ O@20°C, mH ₂ O@4°C, mH ₂ O@20°C, inH ₂ O@4°C, inH ₂ O@20°C, inH ₂ O@60°F, mmHg@0°C, inHg@0°C, ftH ₂ O@4°C, ftH ₂ O@20°C, ftH ₂ O@60°F

Accuracy

Pressure 5, 30, 100, 300 psi 1 psi	±0.05% F.S. ±0.075% F.S.
mA	±0.015% of rdg±0.002mA
Volts	±0.015% of reading ±0.002V
Temperature Effect No effect on accuracy on all functions from 18°C to 28°C Add ±0.005% F.S./°C for temps outside of 18°C to 28°C	

11. Maintenance

11.1 Replacing Batteries

Replace batteries as soon as the battery indicator turns on to avoid false measurements. If the batteries discharge too deeply the PCL340 will automatically shut down to avoid battery leakage.

Note: Use only AA size alkaline batteries or optional rechargeable battery pack.

11.2 Cleaning the Unit

Warning

To avoid personal injury or damage to the calibrator, use only the specified replacement parts and do not allow water into the case.

Caution

To avoid damaging the plastic lens and case, do not use solvents or abrasive cleansers.

Clean the calibrator with a soft cloth dampened with water or water and mild soap.

11.3 Service Center Calibration or Repair

Only qualified service personnel should perform calibration, repairs, or servicing not covered in this manual. If the calibrator fails, check the batteries first, and replace them if needed.

Verify that the calibrator is being operated as explained in this manual. If the calibrator is faulty, call Omega's customer service department for an AR number to return the unit. Be sure to pack the calibrator securely, using the original shipping container if it is available.

WARRANTY/DISCLAIMER

OMEGA ENGINEERING, INC. warrants this unit to be free of defects in materials and workmanship for a period of 13 months from date of purchase. OMEGA's Warranty adds an additional one (1) month grace period to the normal one (1) year product warranty to cover handling and shipping time. This ensures that OMEGA's customers receive maximum coverage on each product.

If the unit malfunctions, it must be returned to the factory for evaluation. OMEGA's Customer Service Department will issue an Authorized Return (AR) number immediately upon phone or written request. Upon examination by OMEGA, if the unit is found to be defective, it will be repaired or replaced at no charge. OMEGA's WARRANTY does not apply to defects resulting from any action of the purchaser, including but not limited to mishandling, improper interfacing, operation outside of design limits, improper repair, or unauthorized modification. This WARRANTY is VOID if the unit shows evidence of having been tampered with or shows evidence of having been damaged as a result of excessive corrosion; or current, heat, moisture or vibration; improper specification; misapplication; misuse or other operating conditions outside of OMEGA's control. Components which wear are not warranted, including but not limited to contact points, fuses, and triacs.

OMEGA is pleased to offer suggestions on the use of its various products. However, OMEGA neither assumes responsibility for any omissions or errors nor assumes liability for any damages that result from the use of its products in accordance with information provided by OMEGA, either verbal or written. OMEGA warrants only that the parts manufactured by it will be as specified and free of defects. OMEGA MAKES NO OTHER WARRANTIES OR REPRESENTATIONS OF ANY KIND WHATSOEVER, EXPRESS OR IMPLIED, EXCEPT THAT OF TITLE, AND ALL IMPLIED WARRANTIES INCLUDING ANY WARRANTY OF MERCHANTABILITY AND FITNESS FOR A PARTICULAR PURPOSE ARE HEREBY DISCLAIMED. LIMITATION OF LIABILITY: The remedies of purchaser set forth herein are exclusive, and the total liability of OMEGA with respect to this order, whether based on contract, warranty, negligence, indemnification, strict liability or otherwise, shall not exceed the purchase price of the component upon which liability is based. In no event shall OMEGA be liable for consequential, incidental or special damages.

CONDITIONS: Equipment sold by OMEGA is not intended to be used, nor shall it be used: (1) as a "Basic Component" under 10 CFR 21 (NRC), used in or with any nuclear installation or activity; or (2) in medical applications or used on humans. Should any Product(s) be used in or with any nuclear installation or activity, medical application, used on humans, or misused in any way, OMEGA assumes no responsibility as set forth in our basic WARRANTY/DISCLAIMER language, and, additionally, purchaser will indemnify OMEGA and hold OMEGA harmless from any liability or damage whatsoever arising out of the use of the Product(s) in such a manner.

RETURN REQUESTS/INQUIRIES

Direct all warranty and repair requests/inquiries to the OMEGA Customer Service Department. BEFORE RETURNING ANY PRODUCT(S) TO OMEGA, PURCHASER MUST OBTAIN AN AUTHORIZED RETURN (AR) NUMBER FROM OMEGA'S CUSTOMER SERVICE DEPARTMENT (IN ORDER TO AVOID PROCESSING DELAYS). The assigned AR number should then be marked on the outside of the return package and on any correspondence.

The purchaser is responsible for shipping charges, freight, insurance and proper packaging to prevent breakage in transit.

FOR WARRANTY RETURNS, please have the following information available BEFORE contacting OMEGA:

1. Purchase Order number under which the product was PURCHASED,
2. Model and serial number of the product under warranty, and
3. Repair instructions and/or specific problems relative to the product.

FOR NON-WARRANTY REPAIRS, consult OMEGA for current repair charges. Have the following information available BEFORE contacting OMEGA:

1. Purchase Order number to cover the COST of the repair,
2. Model and serial number of the product, and
3. Repair instructions and/or specific problems relative to the product.

OMEGA's policy is to make running changes, not model changes, whenever an improvement is possible. This affords our customers the latest in technology and engineering.

OMEGA is a registered trademark of OMEGA ENGINEERING, INC.

© Copyright 2004 OMEGA ENGINEERING, INC. All rights reserved. This document may not be copied, photocopied, reproduced, translated, or reduced to any electronic medium or machine-readable form, in whole or in part, without the prior written consent of OMEGA ENGINEERING, INC.

Where Do I Find Everything I Need for Process Measurement and Control? OMEGA...Of Course!

Shop online at www.omega.com

TEMPERATURE

- Thermocouple, RTD & Thermistor Probes, Connectors, Panels & Assemblies
- Wire: Thermocouple, RTD & Thermistor
- Calibrators & Ice Point References
- Recorders, Controllers & Process Monitors
- Infrared Pyrometers

PRESSURE, STRAIN AND FORCE

- Transducers & Strain Gages
- Load Cells & Pressure Gages
- Displacement Transducers
- Instrumentation & Accessories

FLOW/LEVEL

- Rotameters, Gas Mass Flowmeters & Flow Computers
- Air Velocity Indicators
- Turbine/Paddlewheel Systems
- Totalizers & Batch Controllers

pH/CONDUCTIVITY

- pH Electrodes, Testers & Accessories
- Benchtop/Laboratory Meters
- Controllers, Calibrators, Simulators & Pumps
- Industrial pH & Conductivity Equipment

DATA ACQUISITION

- Data Acquisition & Engineering Software
- Communications-Based Acquisition Systems
- Plug-in Cards for Apple, IBM & Compatibles
- Datalogging Systems
- Recorders, Printers & Plotters

HEATERS

- Heating Cable
- Cartridge & Strip Heaters
- Immersion & Band Heaters
- Flexible Heaters
- Laboratory Heaters

ENVIRONMENTAL MONITORING AND CONTROL

- Metering & Control Instrumentation
- Refractometers
- Pumps & Tubing
- Air, Soil & Water Monitors
- Industrial Water & Wastewater Treatment
- pH, Conductivity & Dissolved Oxygen Instruments